

Kenneth Thompson

A sample of work

CONTENTS

New Orleans Housing
Light and Water Studies
Boulevard Natatorium
Piedmont Park Pavilion
College of Architecture Analysis
Sun Path Structure

New Orleans Housing

A mixed use housing complex in the Holy Cross neighborhood of New Orleans.

OVERALL RENDERING

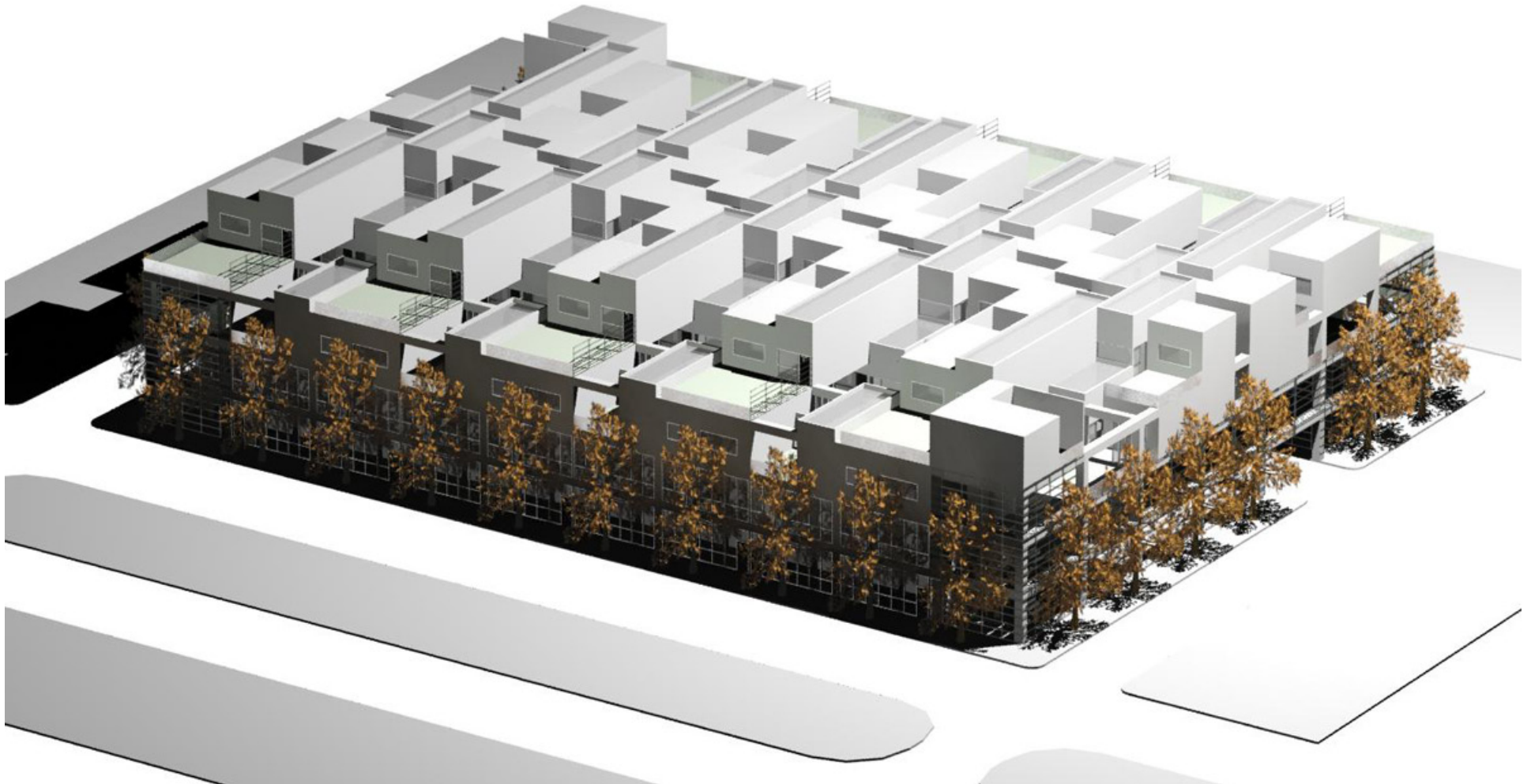

FIRST FLOOR PLAN

SECOND FLOOR PLAN

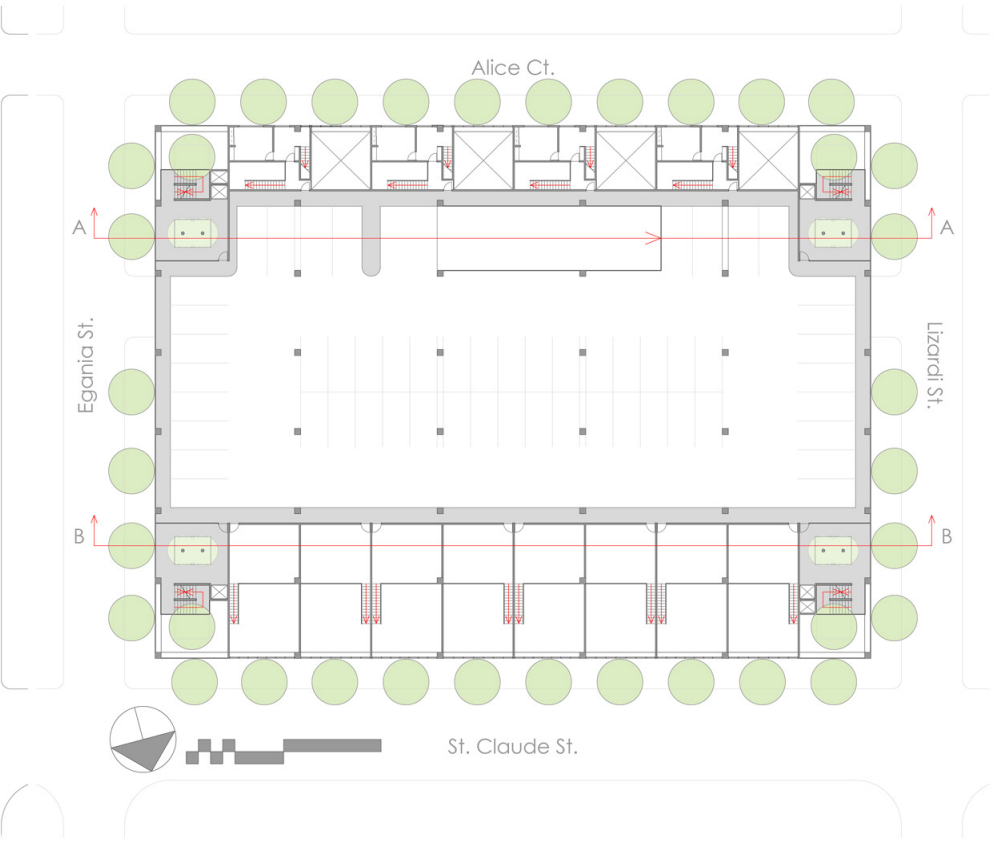

THIRD FLOOR PLAN

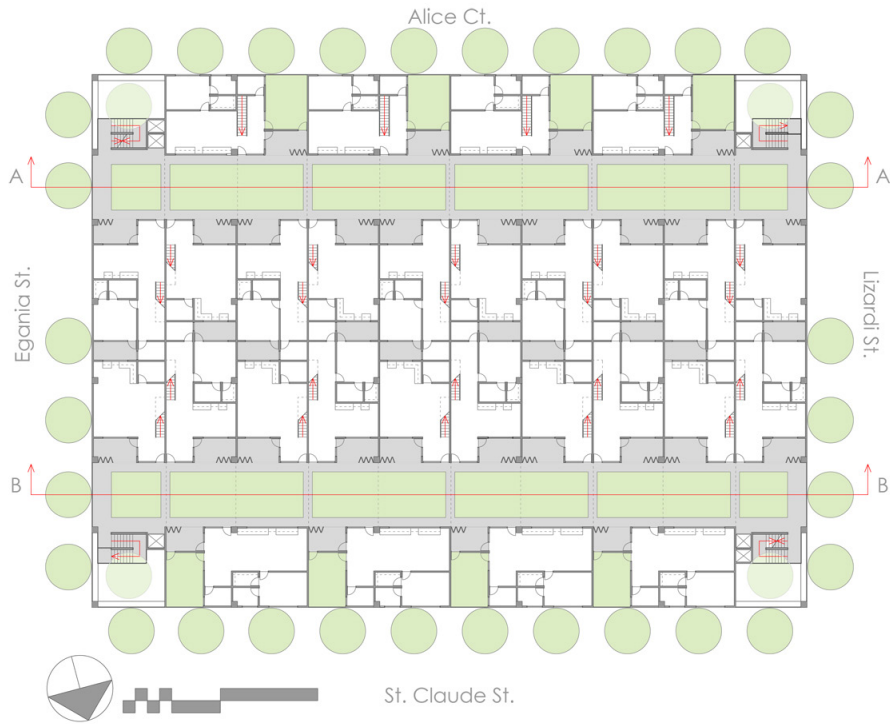

FOURTH FLOOR PLAN

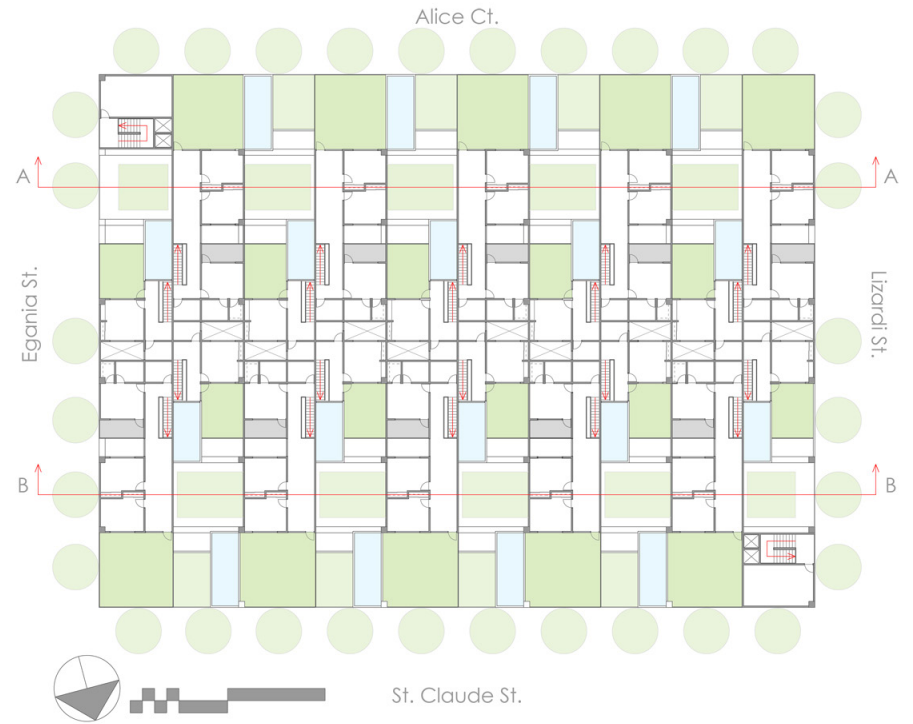

FRONT ELEVATION

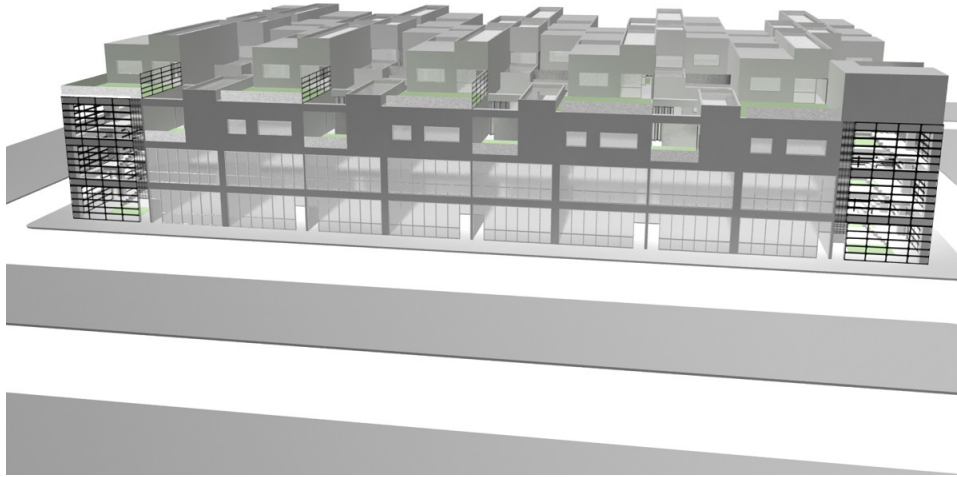

SIDE ELEVATION

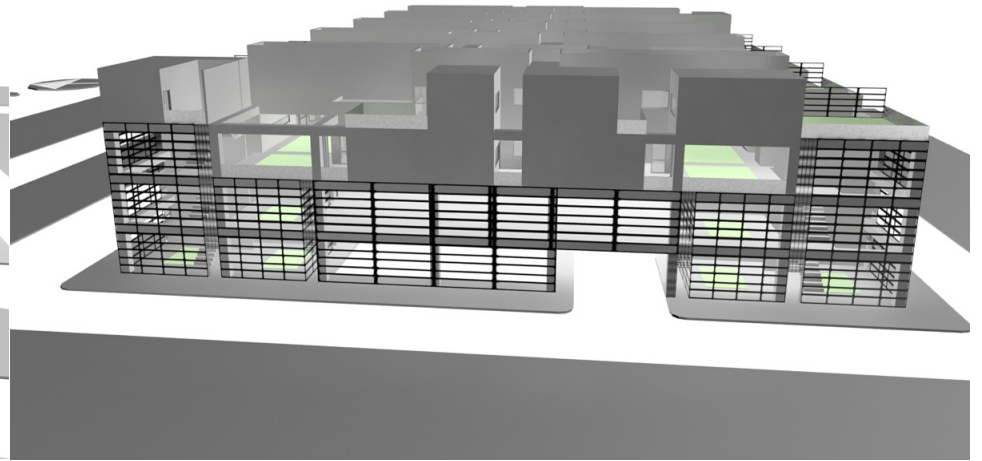

SECTION A

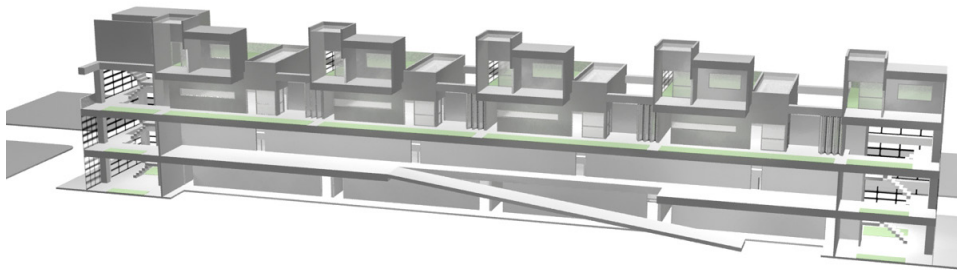

SECTION B

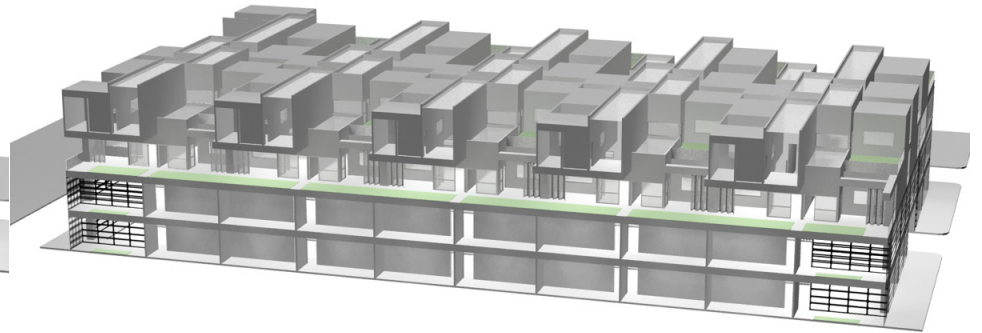

STREET VIEW RENDERING

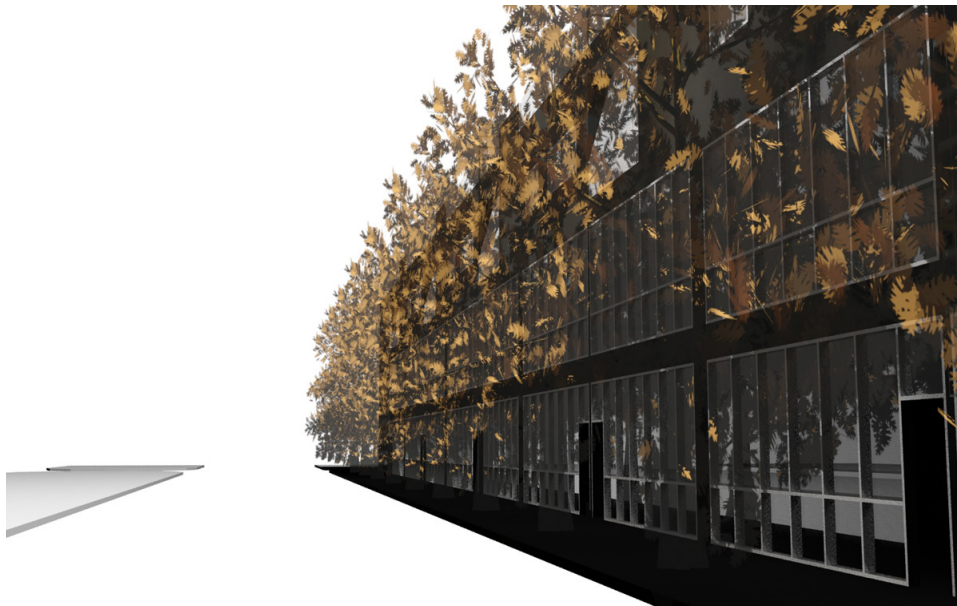

INTERIOR VIEW RENDERING

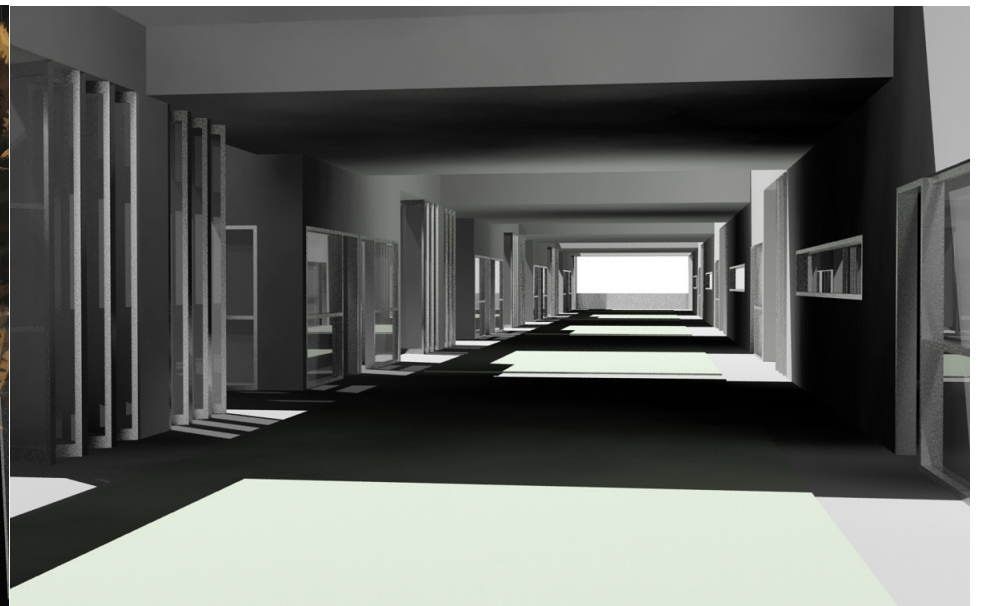

Light and Water Studies

A study of the interaction between light and water.

TRANSLUCENCY



DRAWING

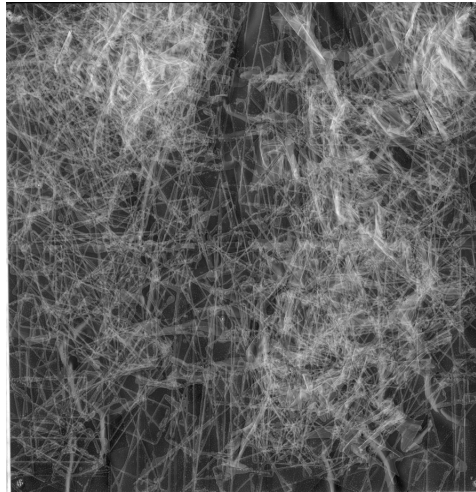

MODEL PLAN

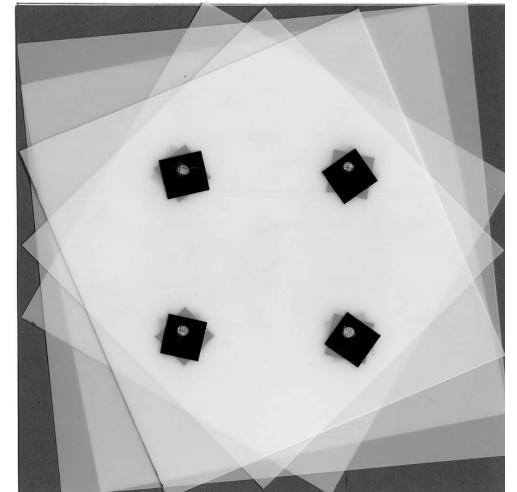

MODEL



MODEL

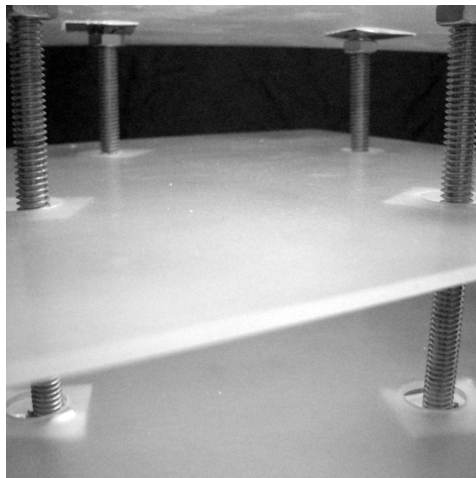

MODEL SECTION

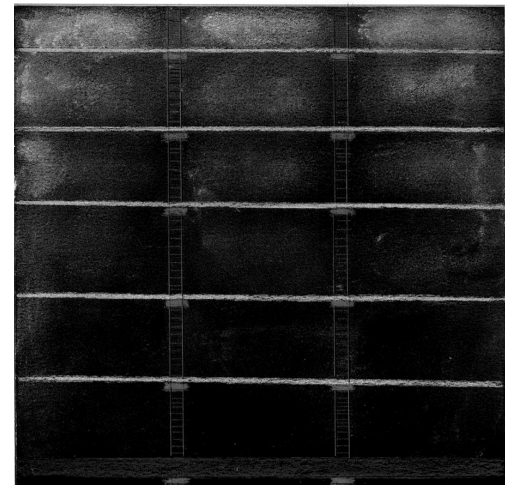

PURIFICATION

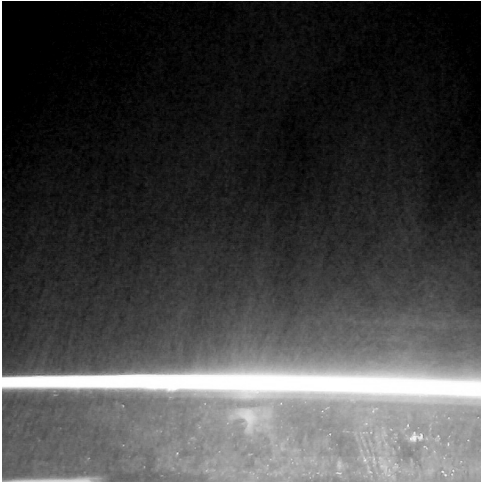

DRAWING

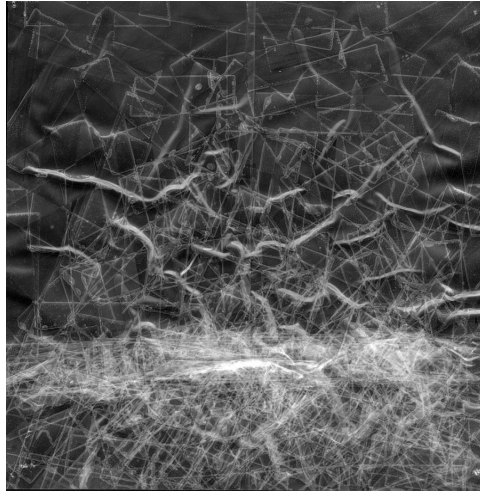

MODEL PLAN

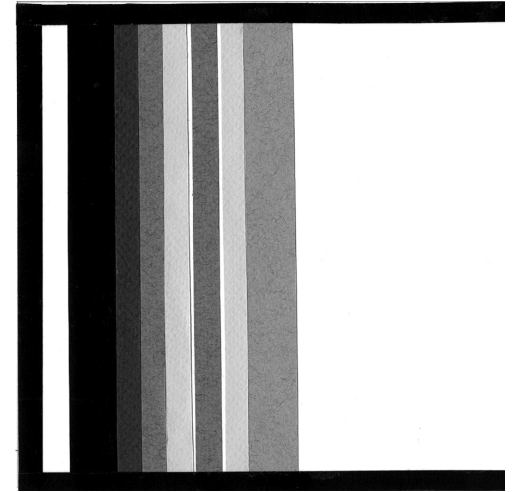

MODEL



MODEL

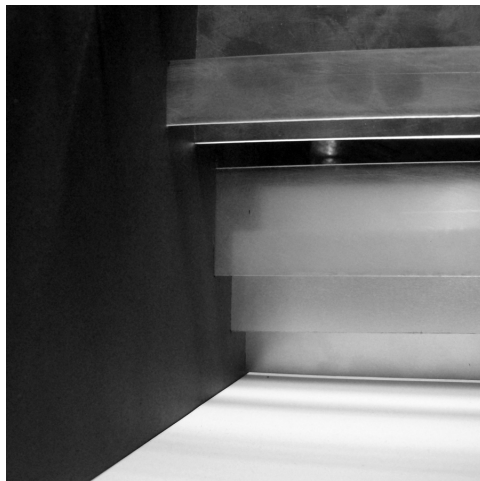

MODEL SECTION

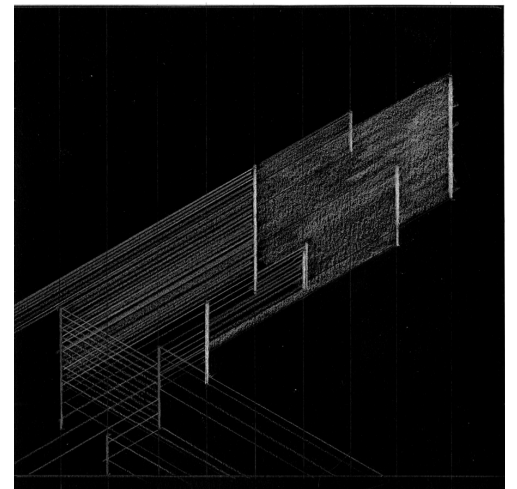

FILTRATION



DRAWING



MODEL PLAN

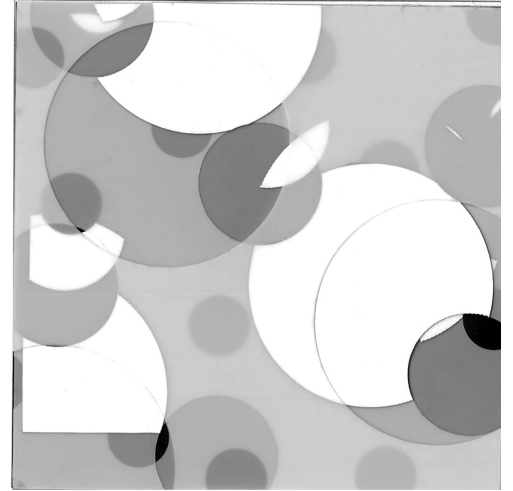

MODEL

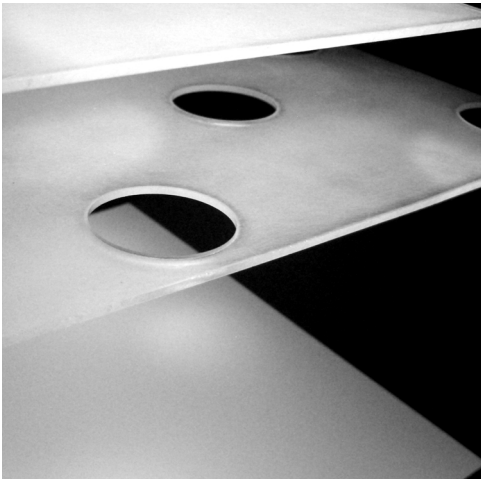

MODEL

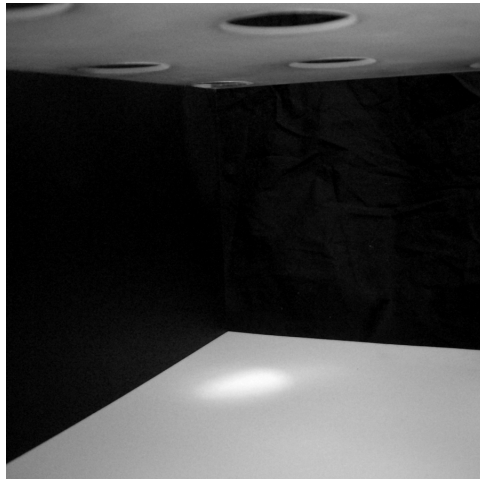

MODEL SECTION

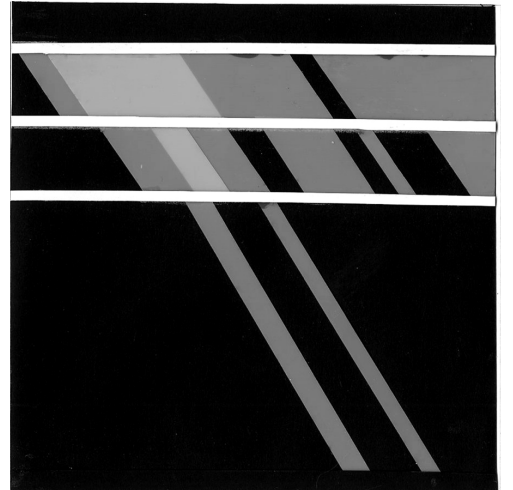

REFLECTION



DRAWING

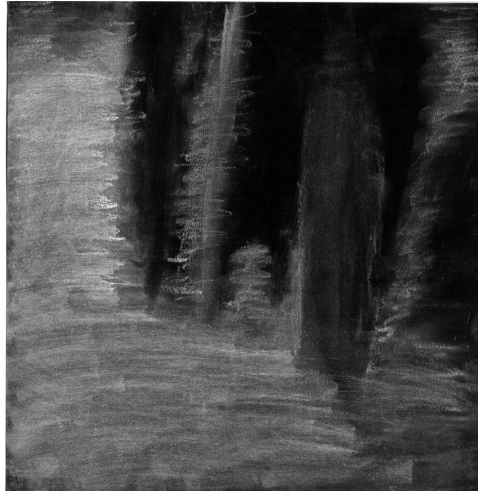

MODEL PLAN



MODEL

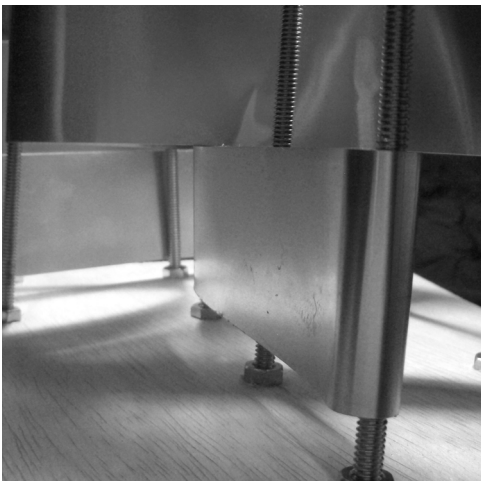

MODEL



MODEL SECTION

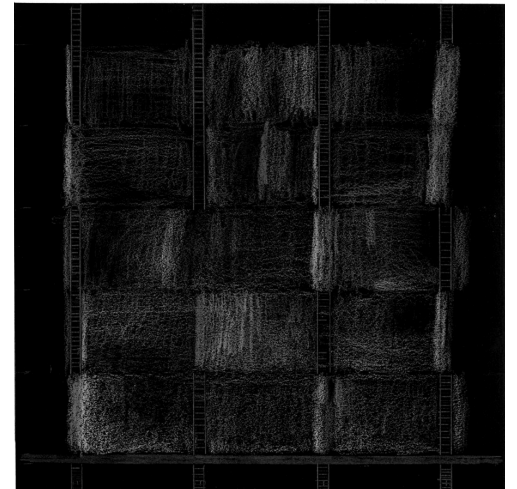

Boulevard Natatorium

A natatorium/water garden/community space on Boulevard in Atlanta inspired by light and water studies.

OVERALL RENDERING

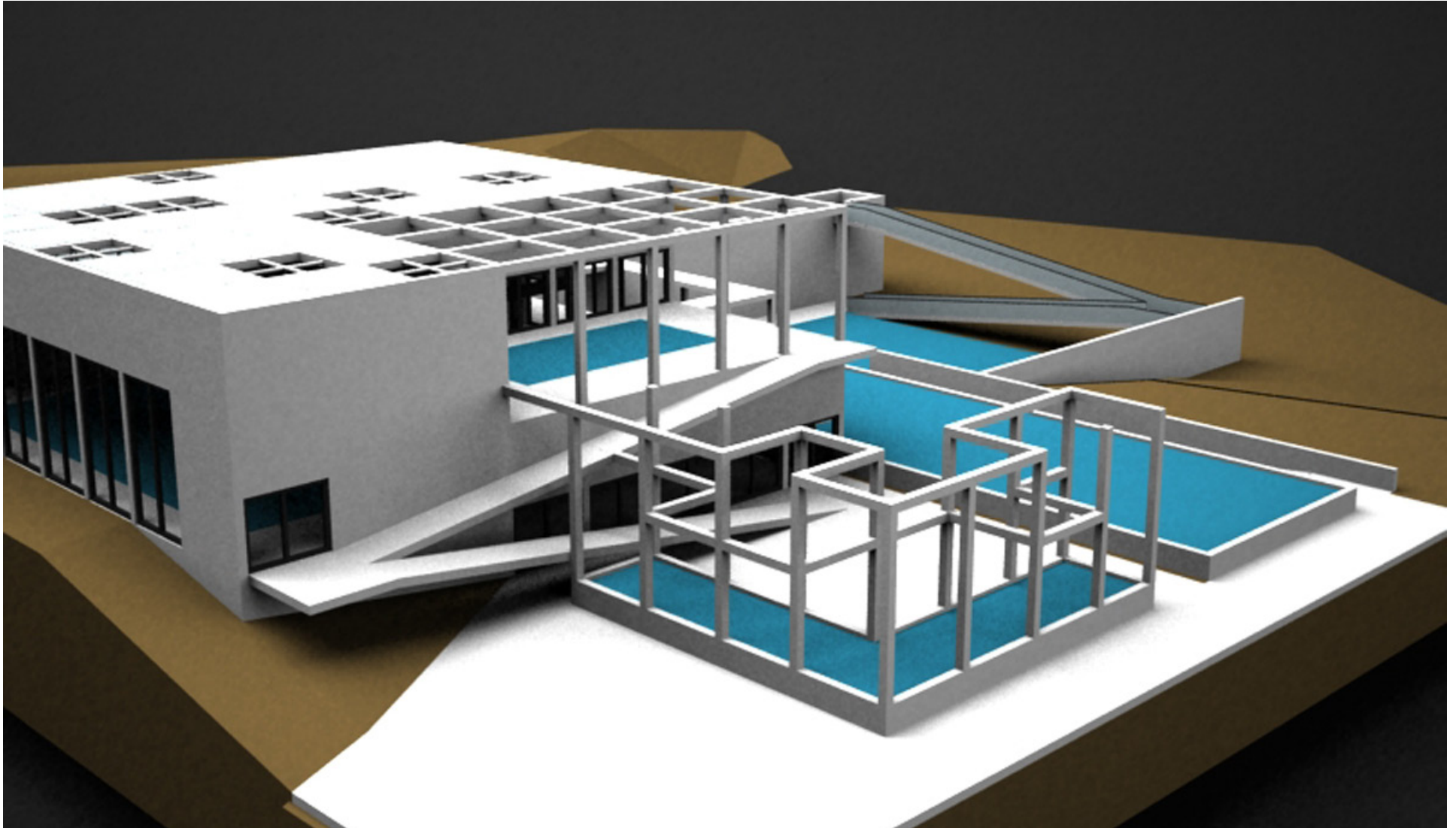

GROUND FLOOR PLAN

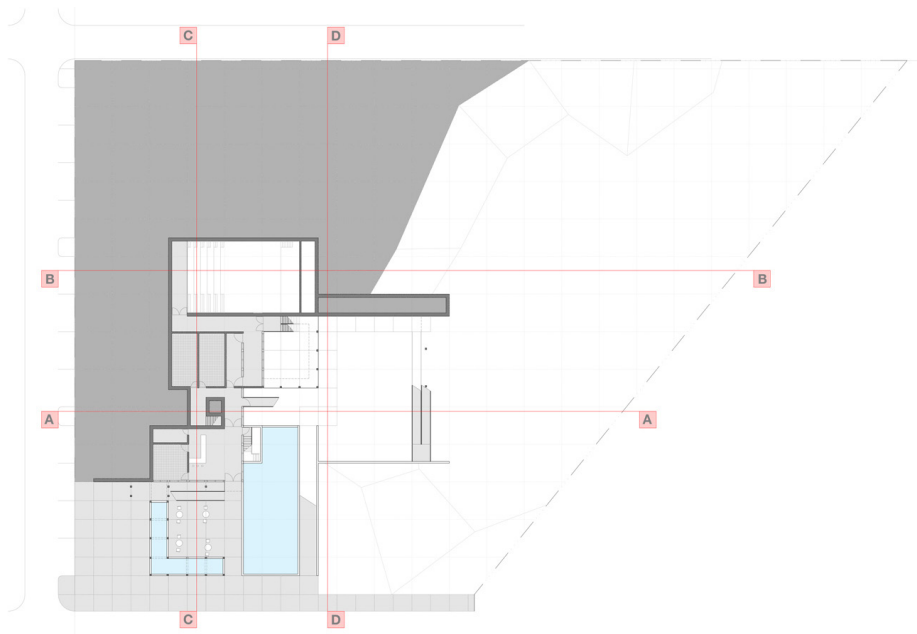

FIRST AND SECOND FLOOR PLANS

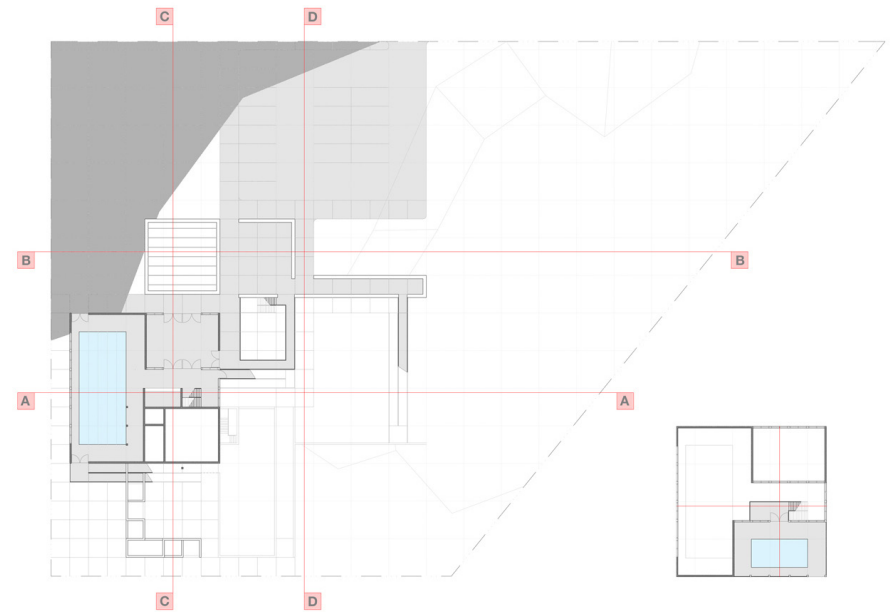

SECTION A

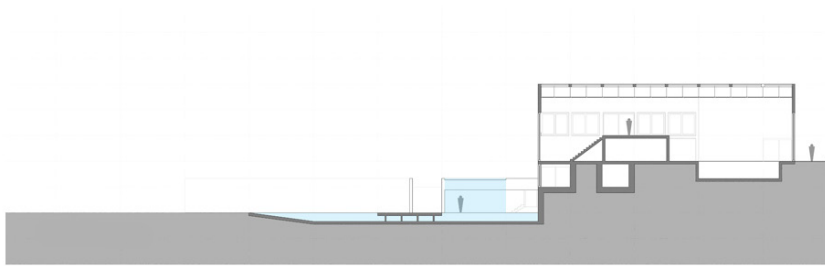

SECTION B

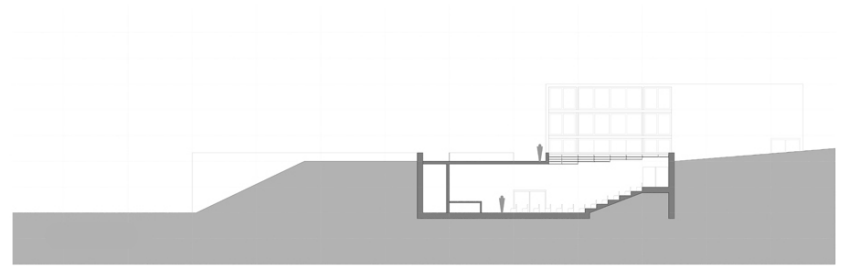

SECTION C

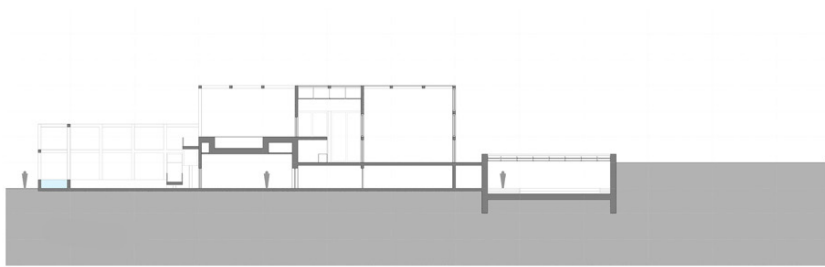

SECTION D

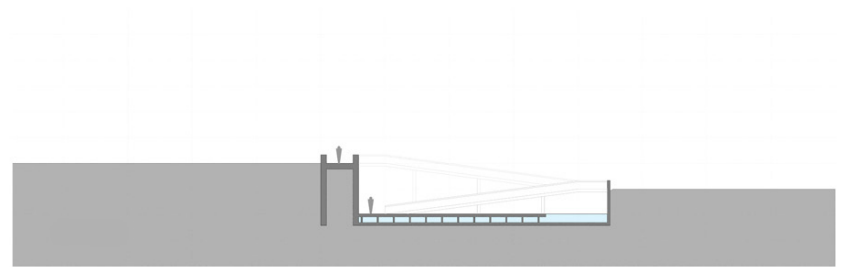

DIAGRAM

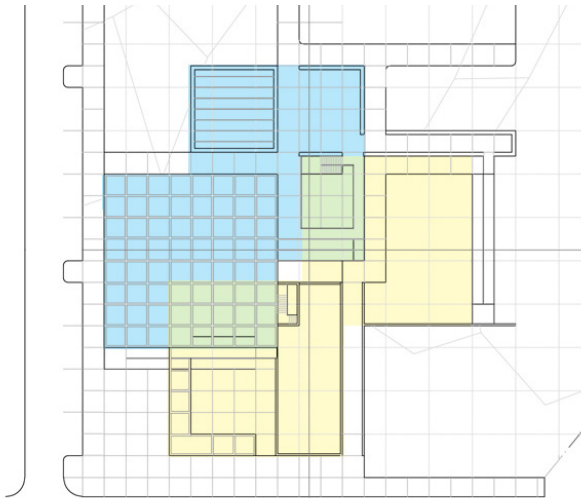

In/Out



DIAGRAM

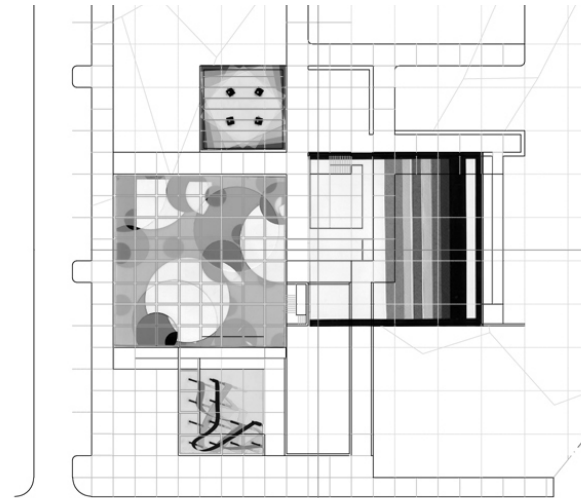

Light/Water Concepts

DIAGRAM

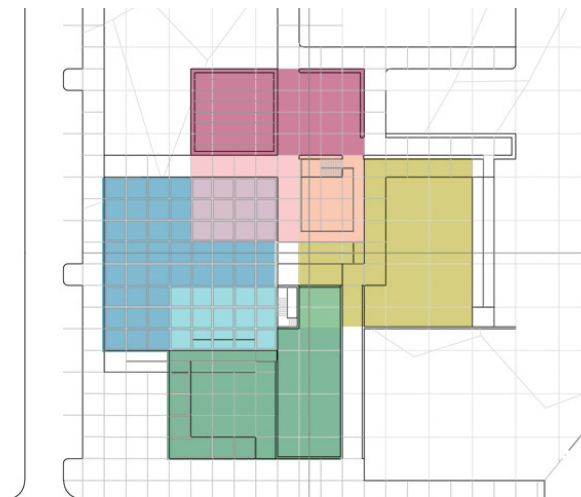

Program



DIAGRAM

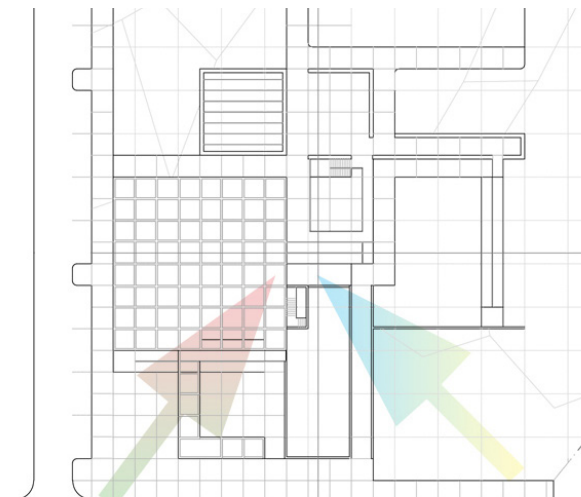

Site Order



POOL LIGHT STUDY MODEL

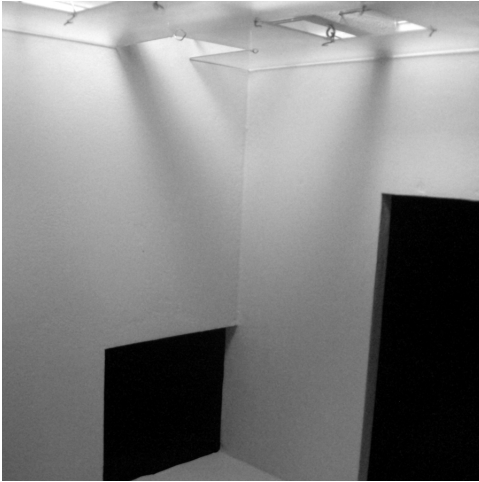

POOL LIGHT STUDY MODEL



POOL LIGHT STUDY MODEL

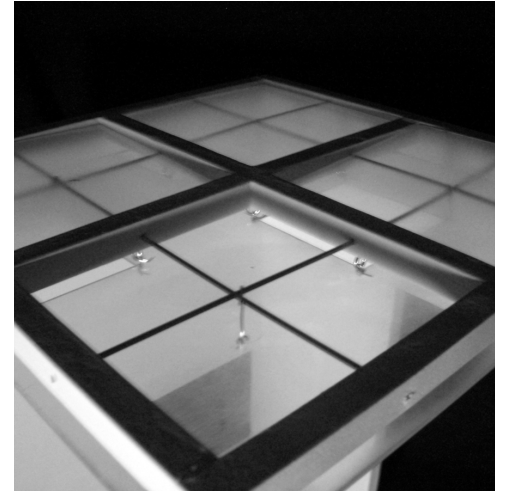

AUDITORIUM LIGHT STUDY MODEL



AUDITORIUM LIGHT STUDY MODEL

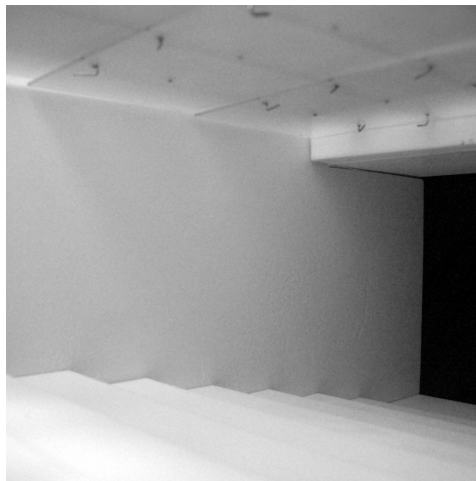

AUDITORIUM LIGHT STUDY MODEL



OVERALL RENDERING

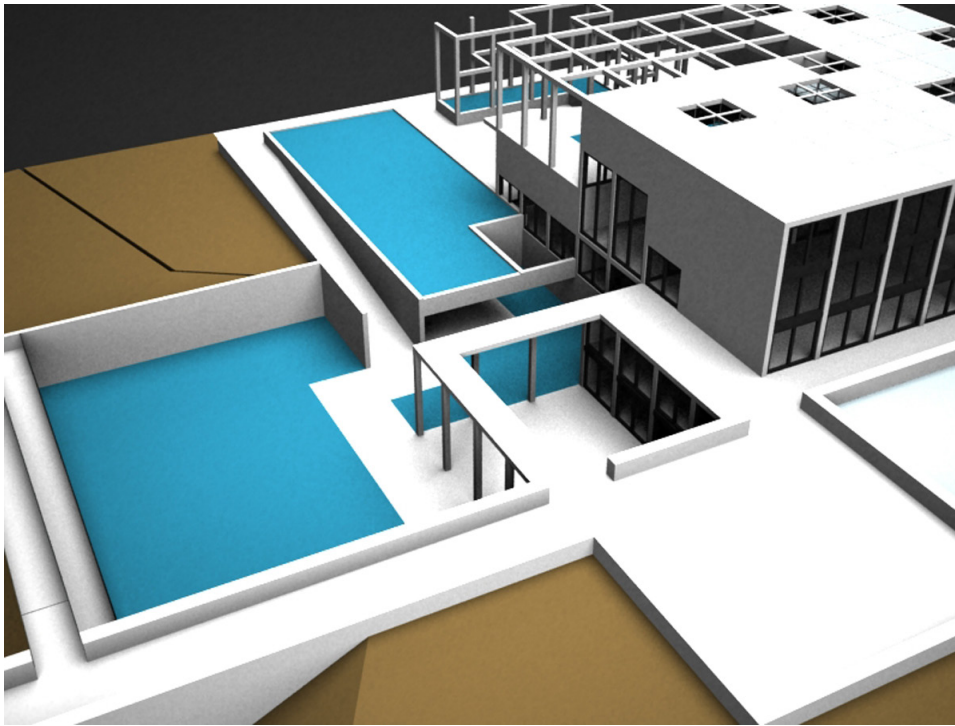

OVERALL RENDERING

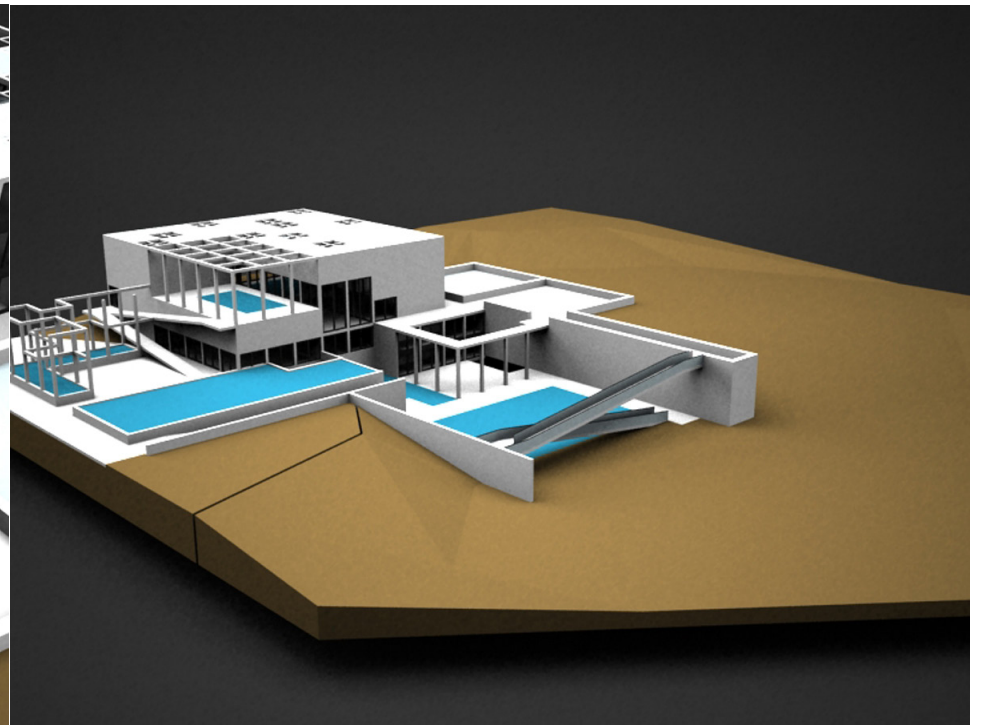

Piedmont Park Pavilion

A pavilion/cafe in Piedmont Park.

OVERALL RENDERING

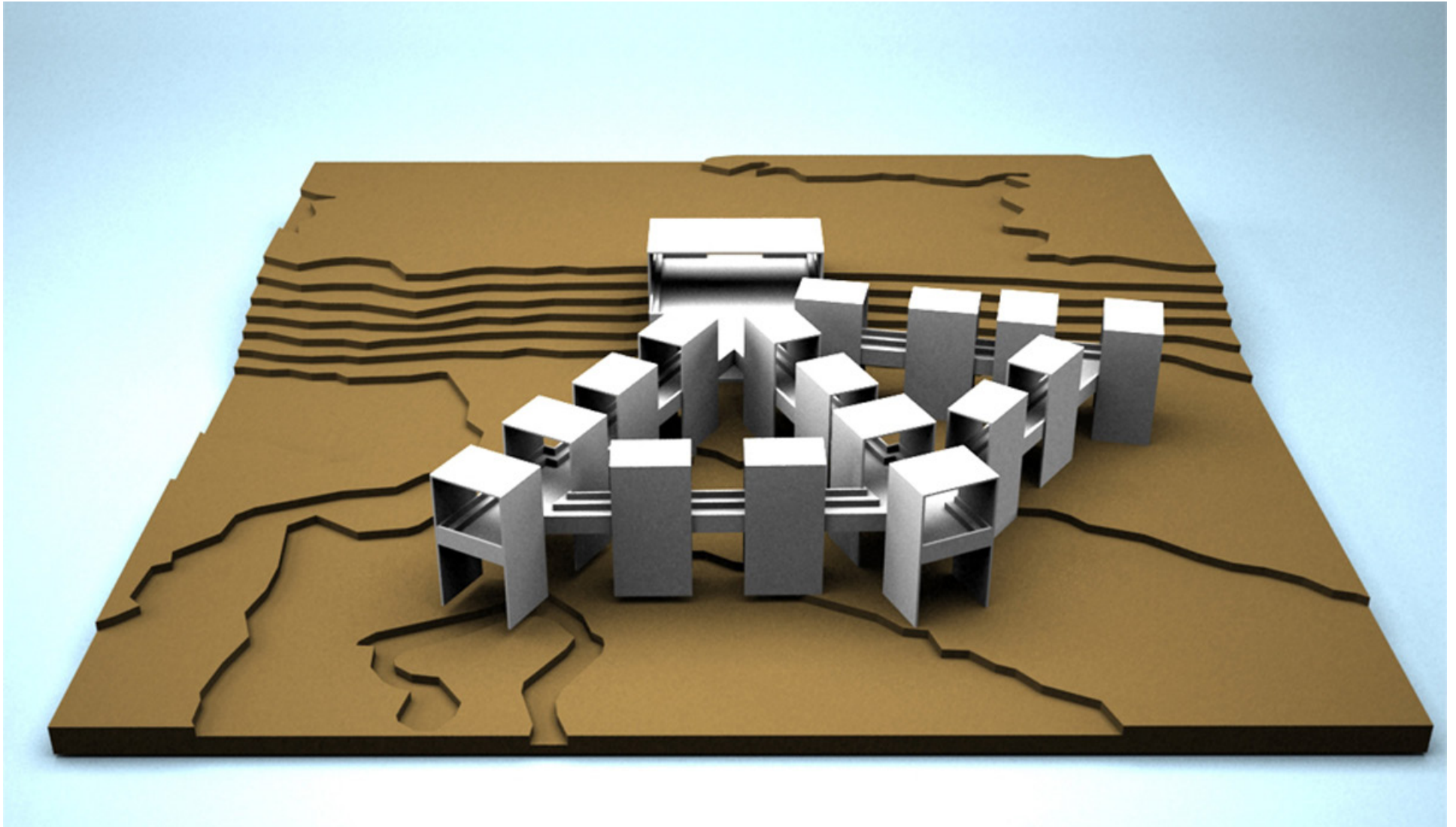

FIRST FLOOR PLAN

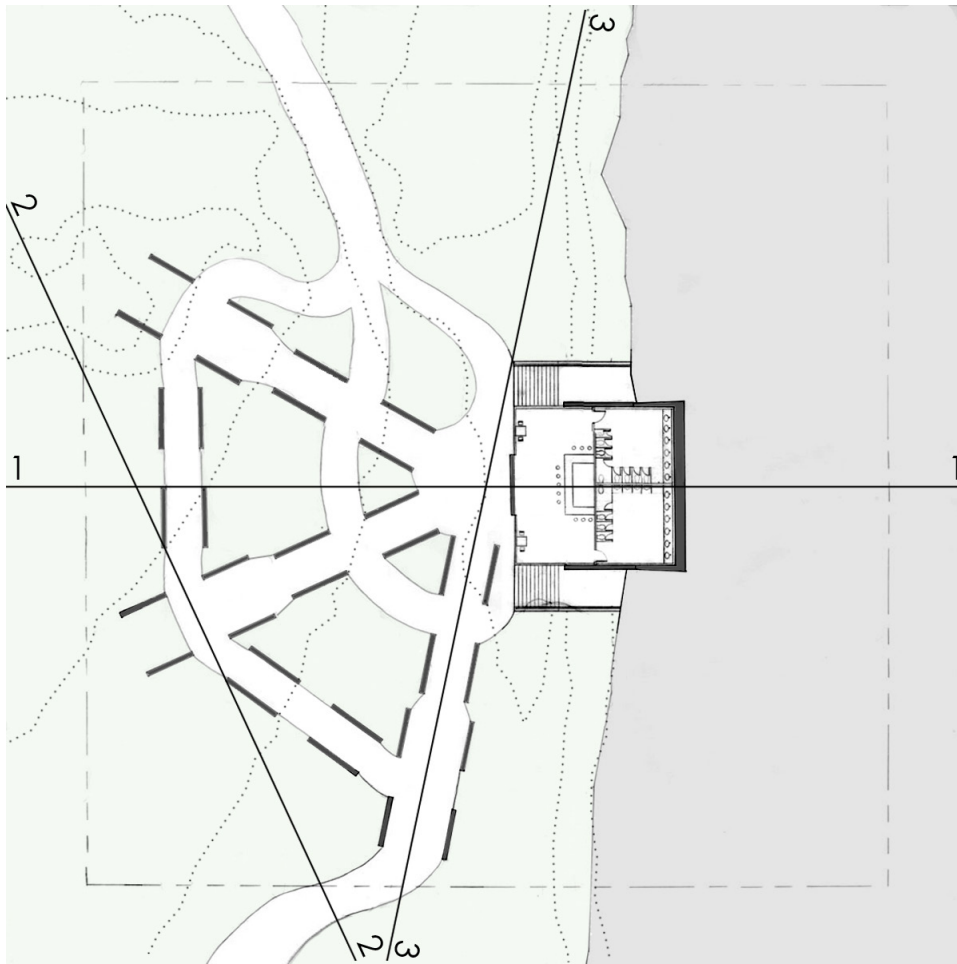

SECOND FLOOR PLAN

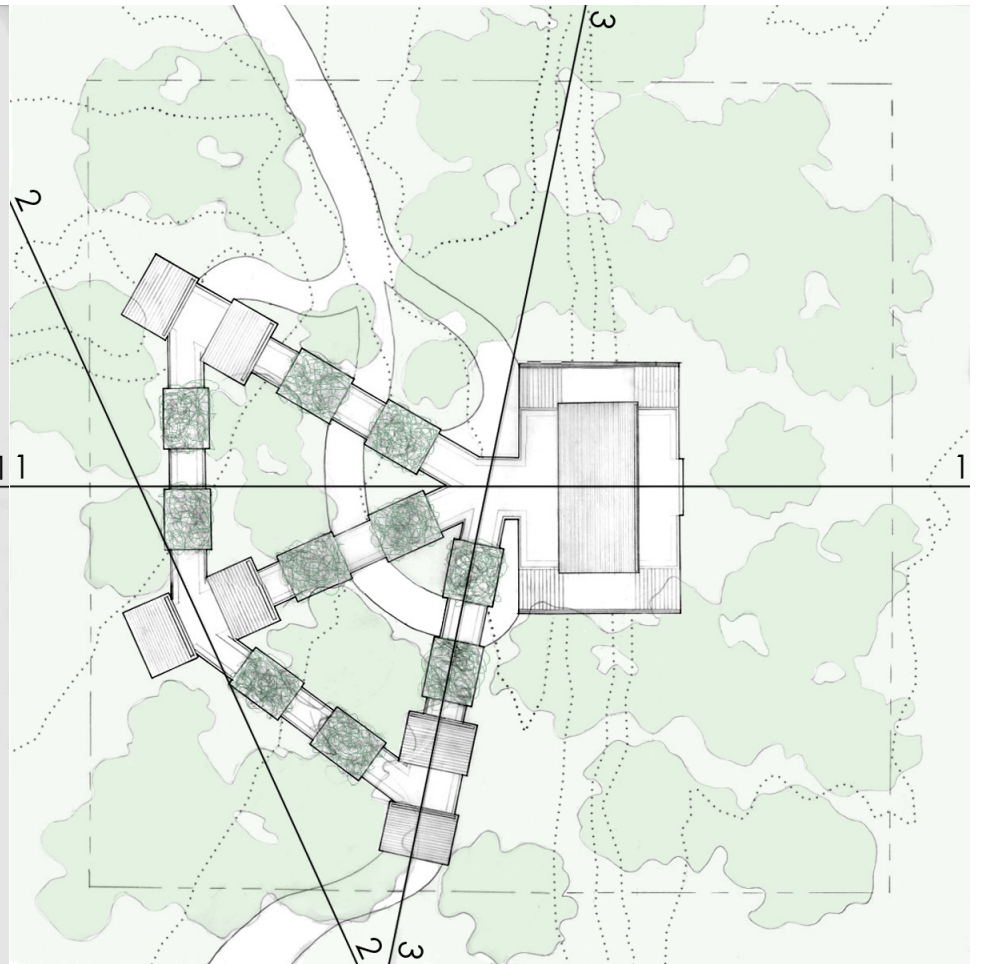

SECTION 1

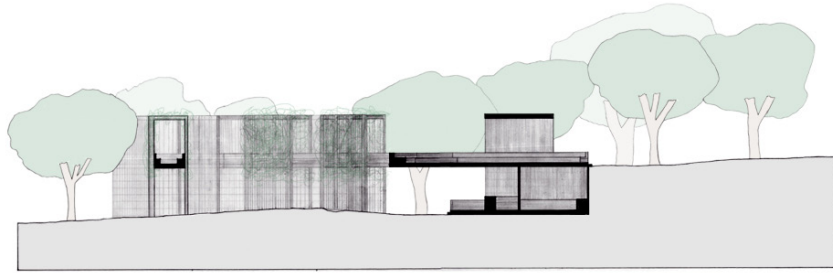

SECTION 2



SECTION 3

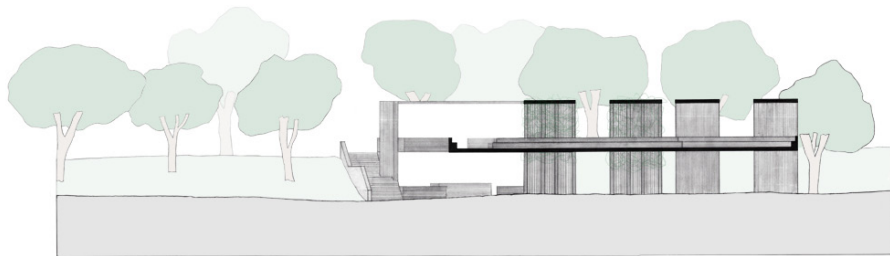

SKETCH OF SHEATHING

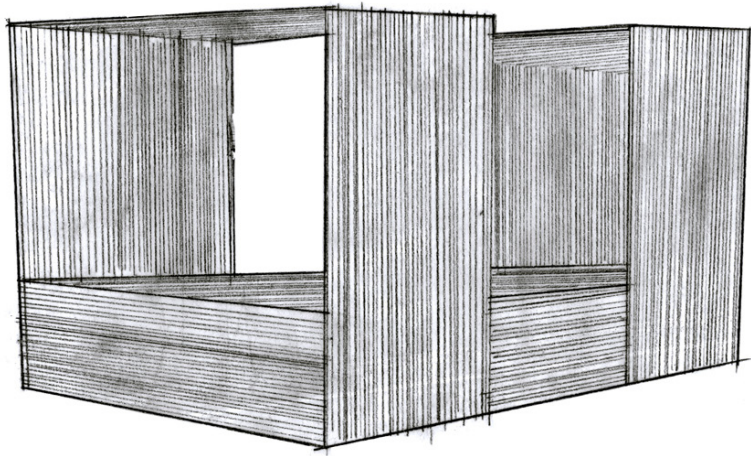

INTERIOR VIEW RENDERING

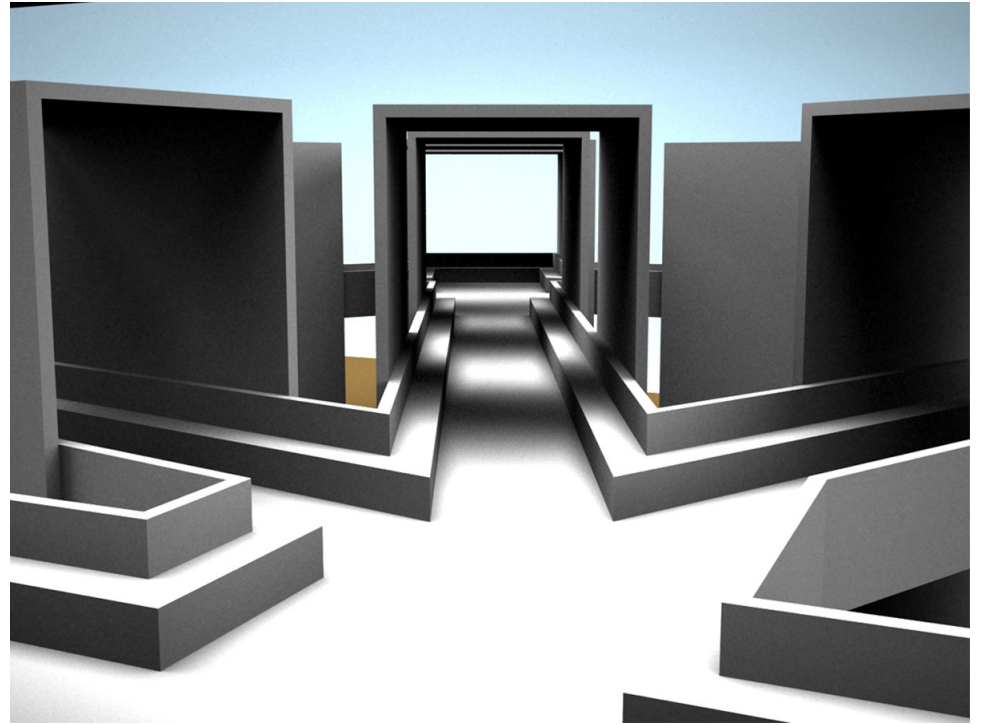

College of Architecture Analysis

An analysis of a path through the Georgia Tech College of Architecture.

OVERALL RENDERING

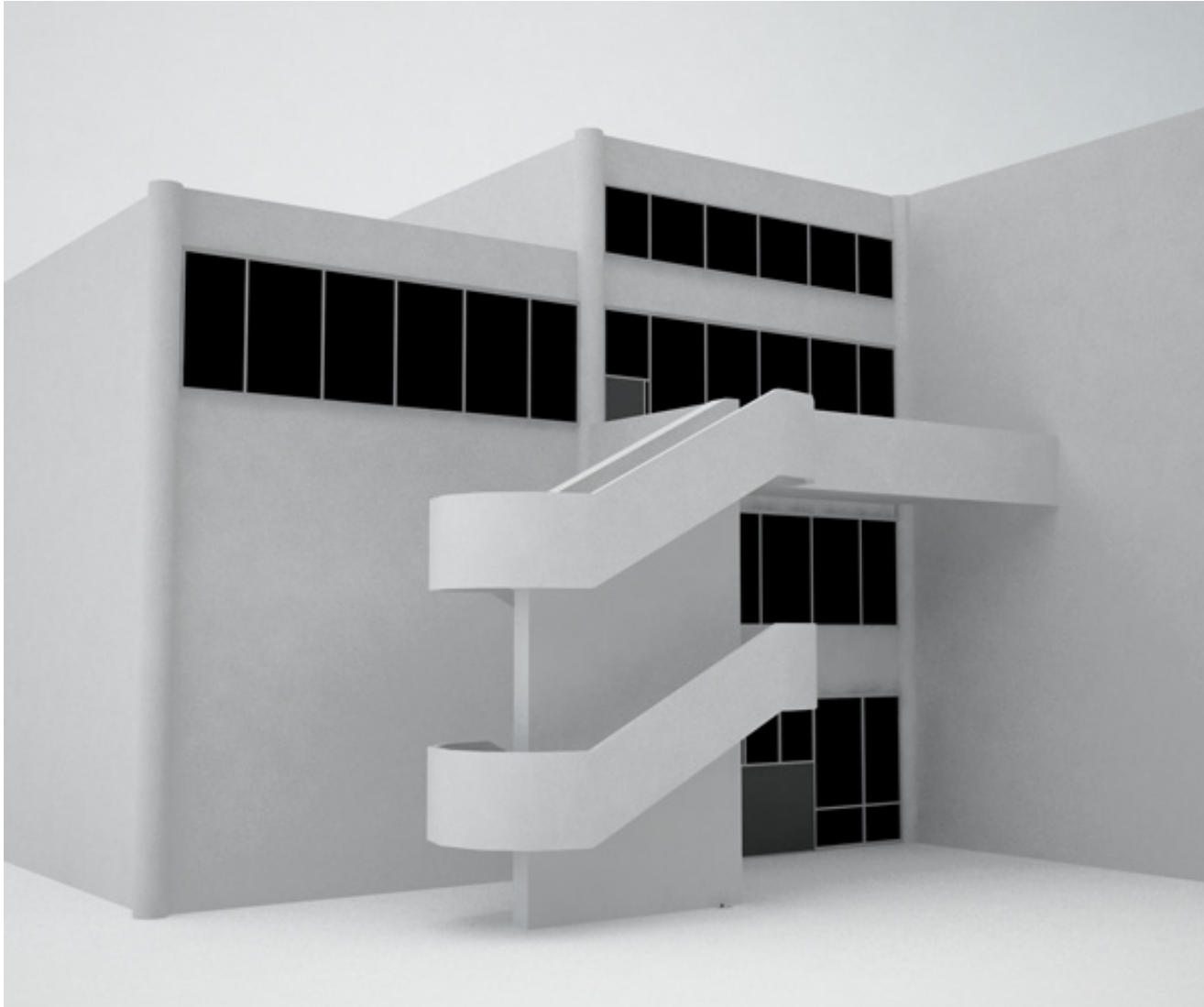

MEASURED DRAWINGS

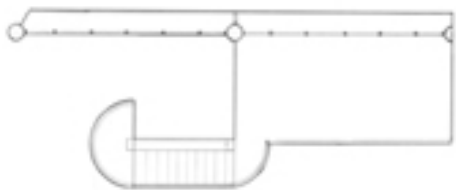
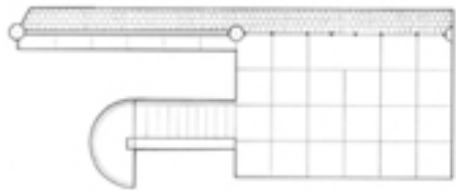

AXONOMETRIC SECTION

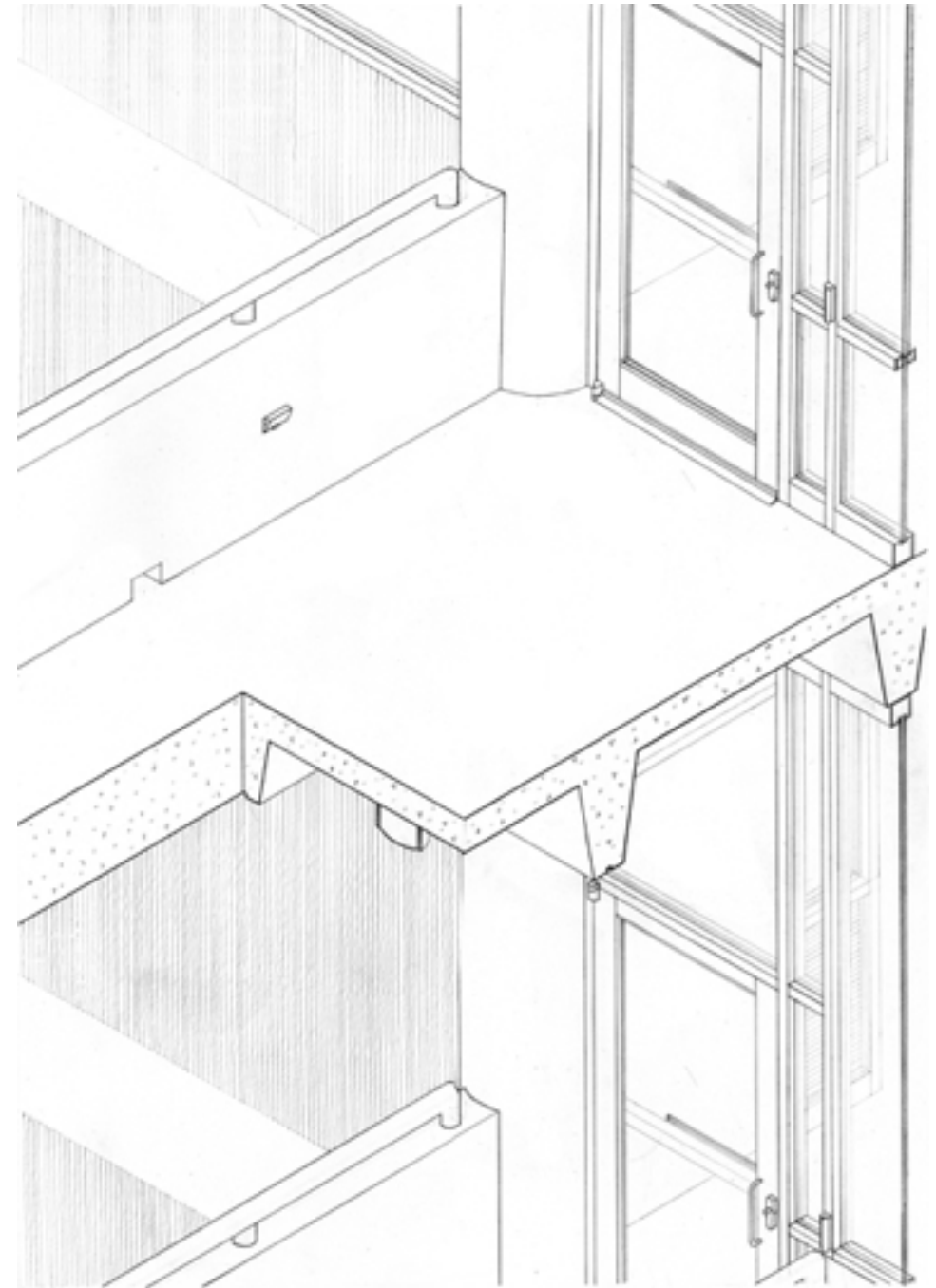

VOLUMETRIC ANALYSES

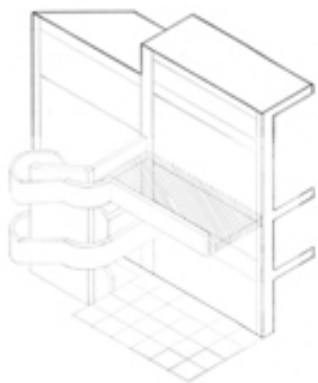
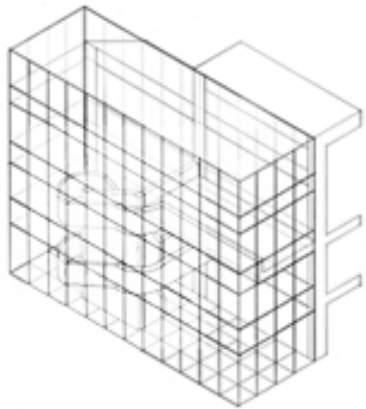

UNFOLDED PATH AND AXONS

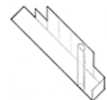
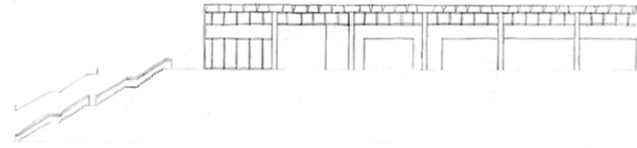

COLLAGE OF SECTION OF PATH



COLLAGE OF SECTION OF PATH



COLLAGE OF SECTION OF PATH



COLLAGE OF SECTION OF PATH



COLLAGE OF SECTION OF PATH



Sun Path Structure

A structure created from an analysis of sun paths and light.

OVERALL MODEL

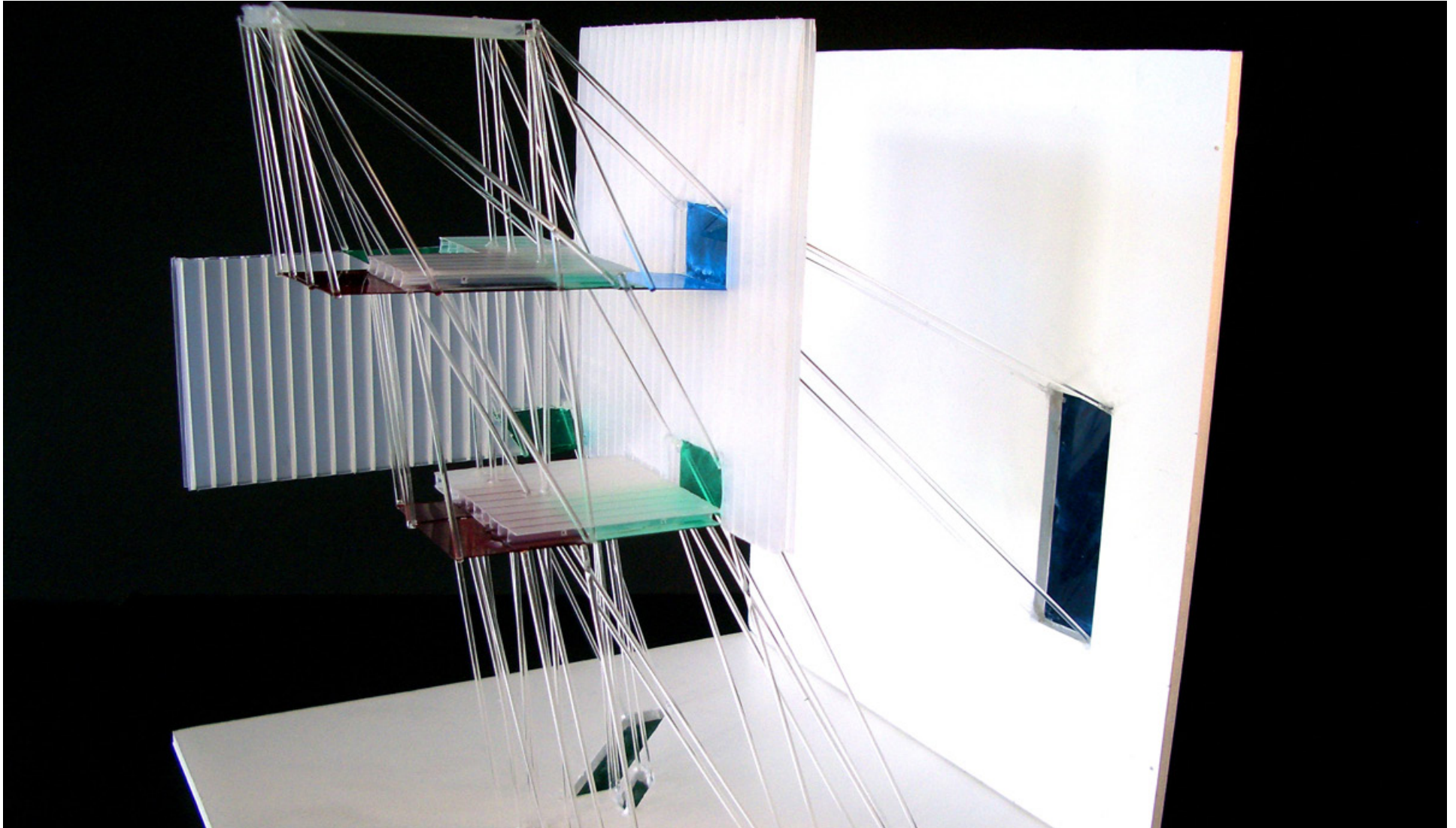

PLAN OF SMALL CUBE

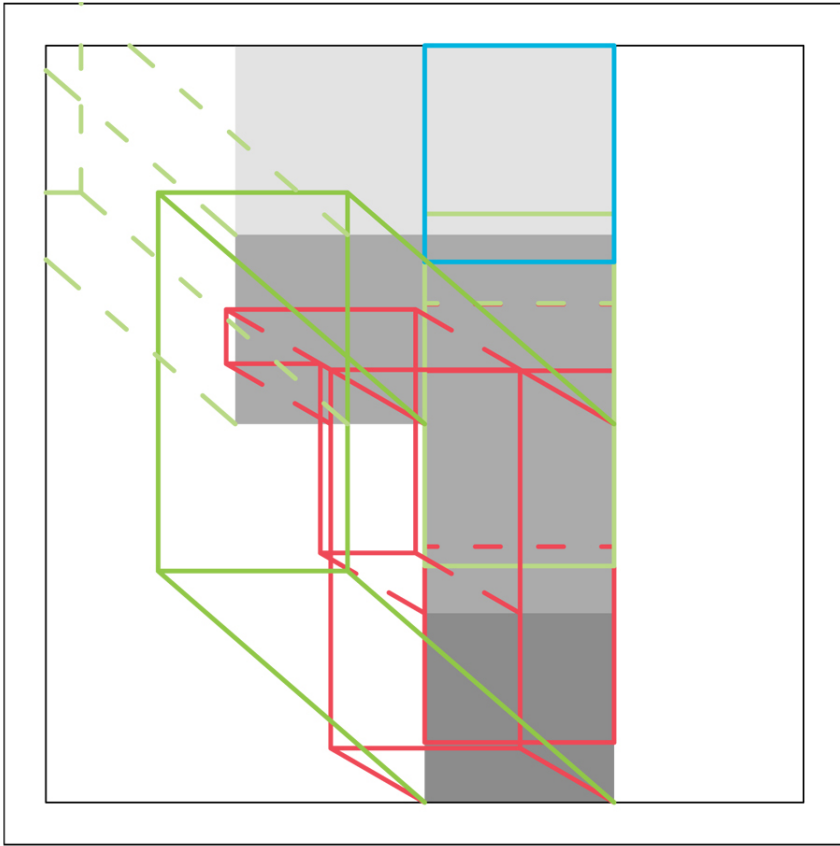

SECTION OF SMALL CUBE

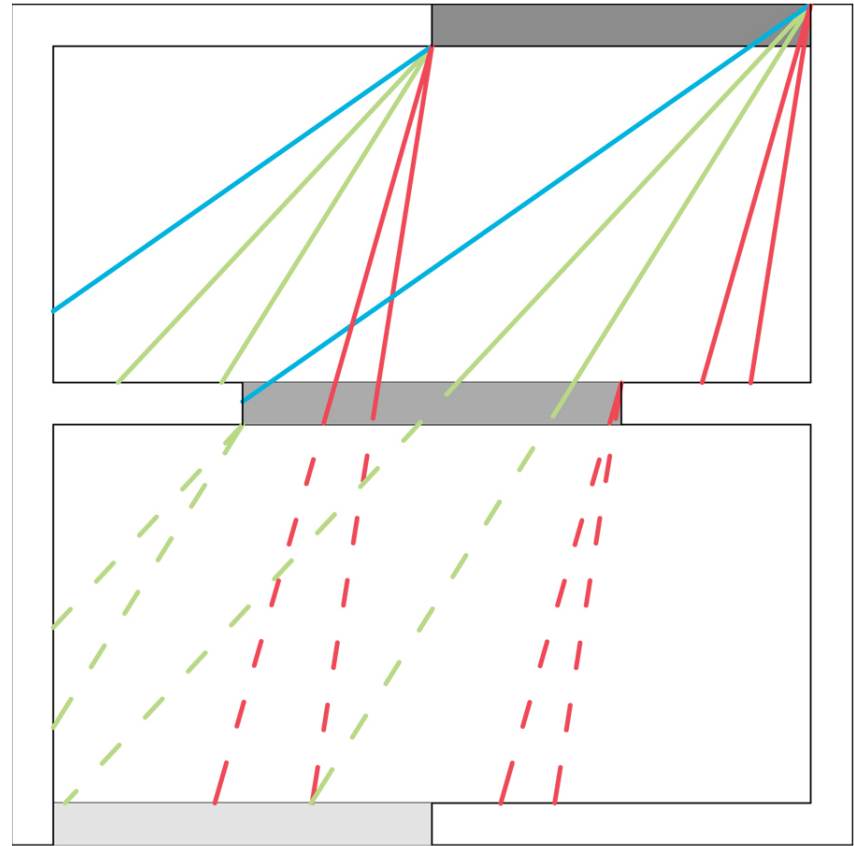

MODEL OF SMALL CUBE

MODEL OF SMALL CUBE

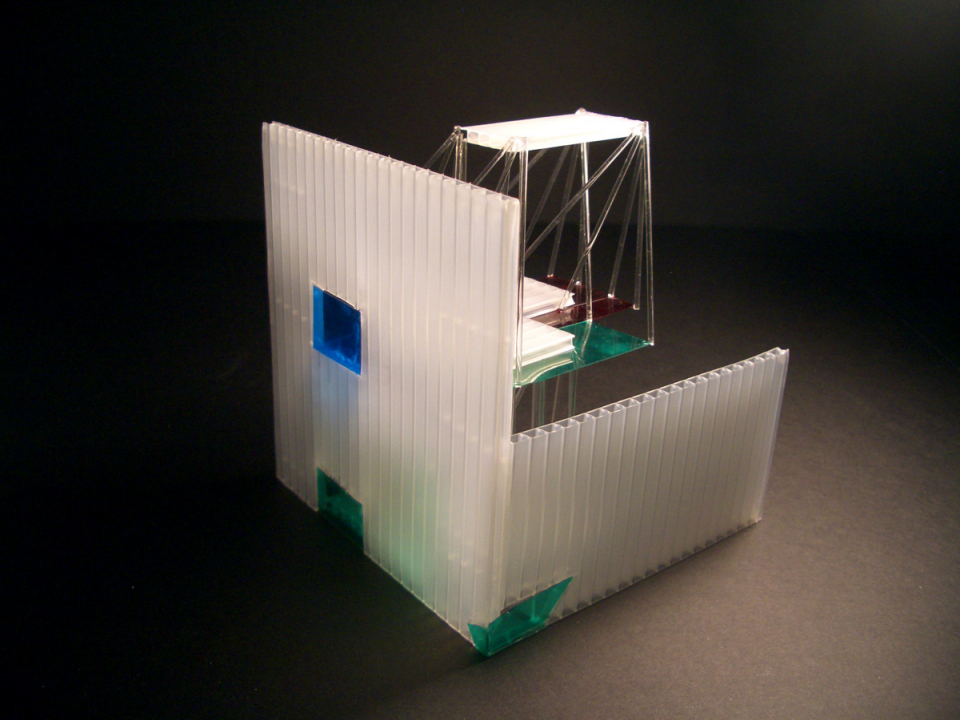
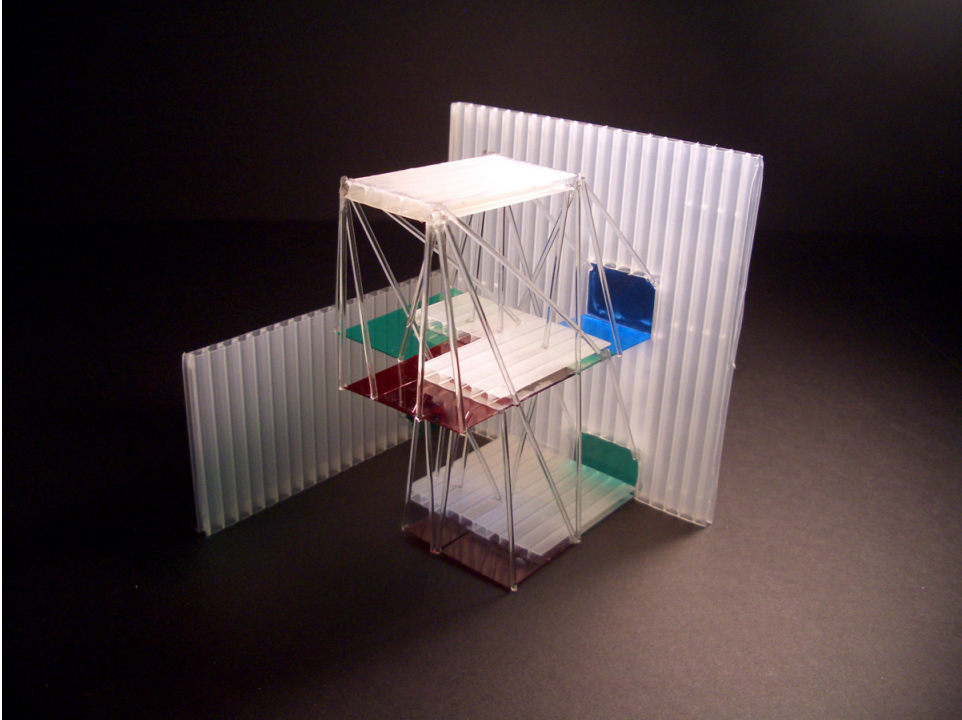

DIAGRAM OF CONCAVE LENS

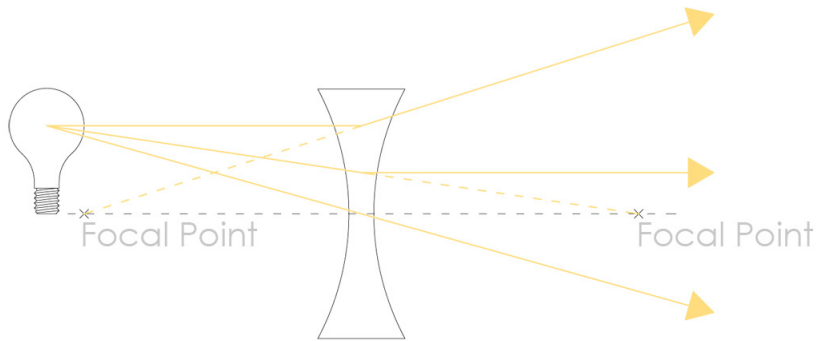
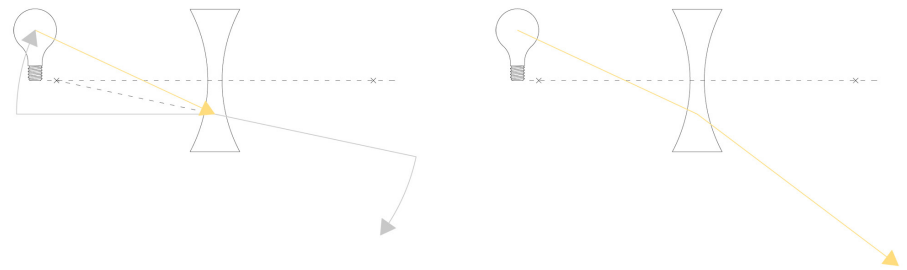
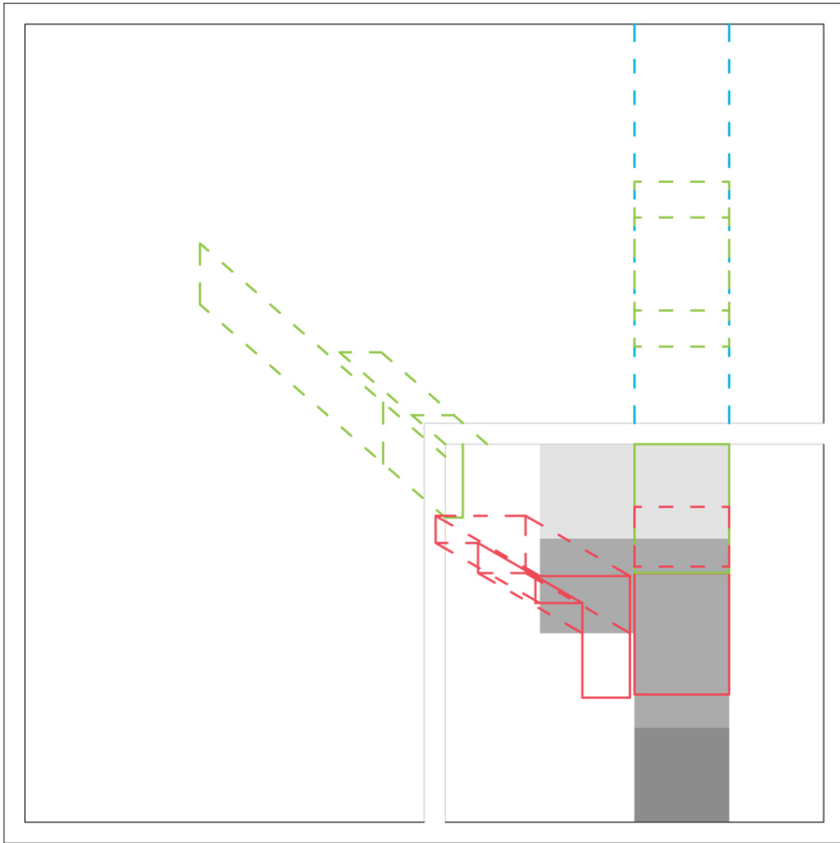

DIAGRAM OF LIGHT DIVERGENCE



PLAN OF LARGE CUBE



SECTION OF LARGE CUBE

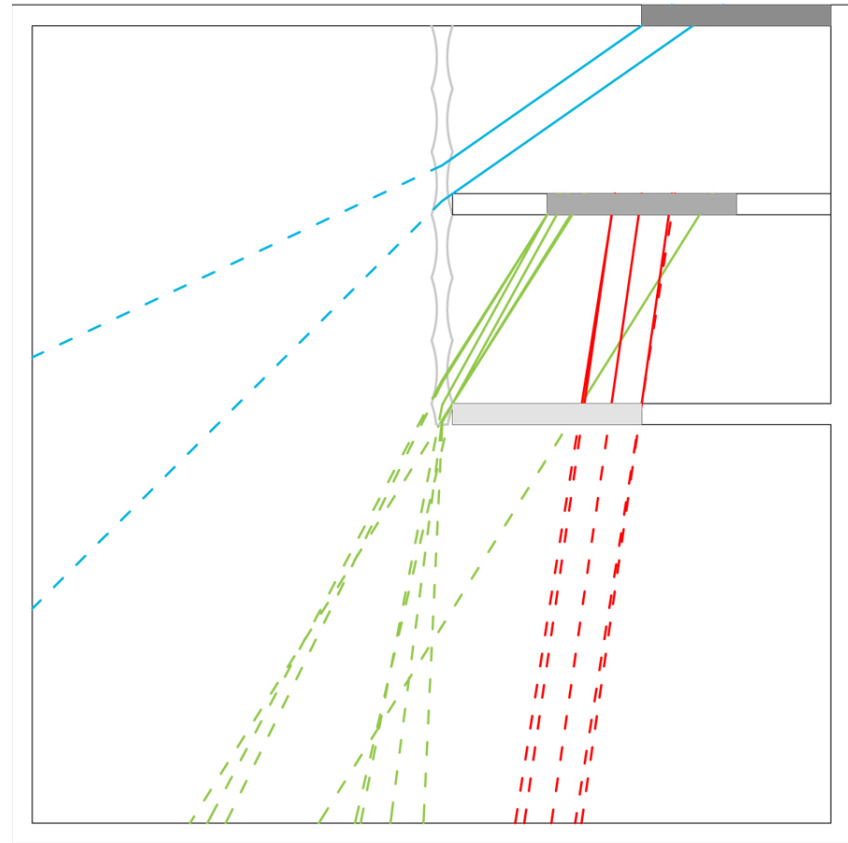

MODEL OF LARGE CUBE

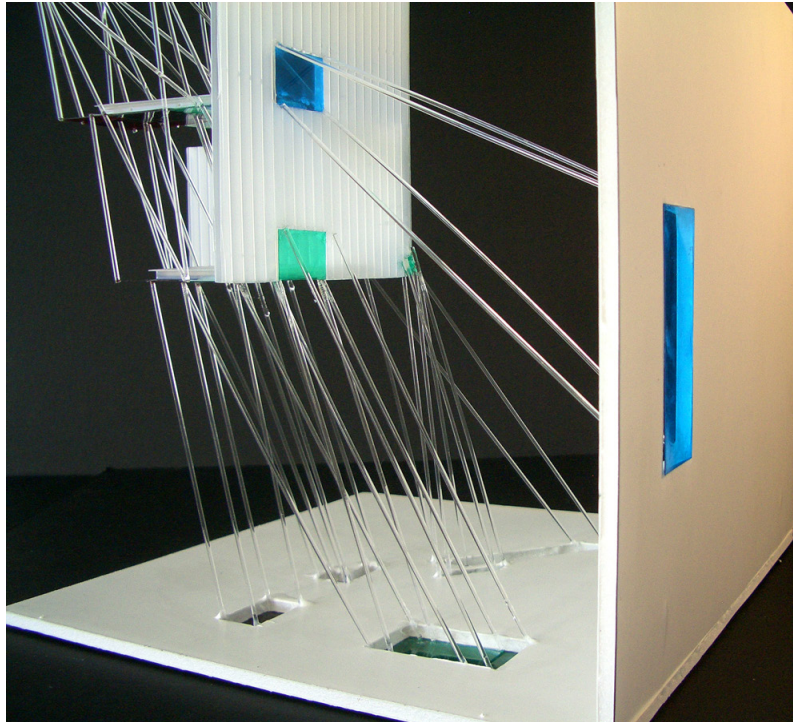

MODEL OF LARGE CUBE

